



Cambridge International Examinations
Cambridge International General Certificate of Secondary Education

CANDIDATE
NAME

--

CENTRE
NUMBER

--	--	--	--	--

CANDIDATE
NUMBER

--	--	--	--



MATHEMATICS

0580/22

Paper 2 (Extended)

October/November 2016

1 hour 30 minutes

Candidates answer on the Question Paper.

Additional Materials: Electronic calculator Geometrical instruments
 Tracing paper (optional)

READ THESE INSTRUCTIONS FIRST

Write your Centre number, candidate number and name on all the work you hand in.

Write in dark blue or black pen.

You may use an HB pencil for any diagrams or graphs.

Do not use staples, paper clips, glue or correction fluid.

DO NOT WRITE IN ANY BARCODES.

Answer **all** questions.

If working is needed for any question it must be shown below that question.

Electronic calculators should be used.

If the degree of accuracy is not specified in the question, and if the answer is not exact, give the answer to three significant figures. Give answers in degrees to one decimal place.

For π , use either your calculator value or 3.142.

At the end of the examination, fasten all your work securely together.

The number of marks is given in brackets [] at the end of each question or part question.

The total of the marks for this paper is 70.

The syllabus is approved for use in England, Wales and Northern Ireland as a Cambridge International Level 1/Level 2 Certificate.

This document consists of **11** printed pages and **1** blank page.

1 (a) Write 14 835 correct to the nearest thousand.

..... [1]

(b) Write your answer to **part (a)** in standard form.

..... [1]

2

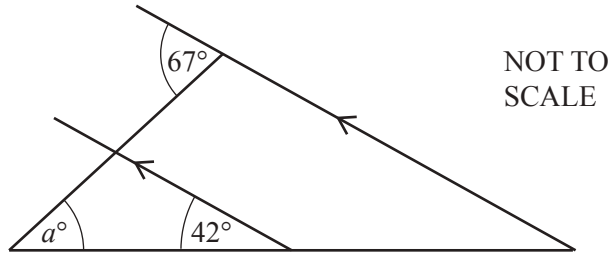

Find the value of a .

$a =$ [2]

3 Solve the equation.

$$6(k - 8) = 78$$

$k =$ [2]

4

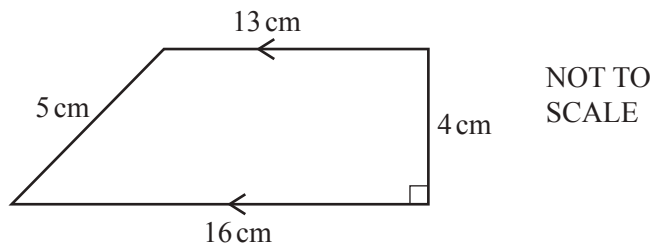

Calculate the area of this trapezium.

..... cm^2 [2]

5 Simplify.

$$36y^5 \div 4y^2$$

..... [2]

6 The sides of a square are 8 cm, correct to the nearest centimetre.

Calculate the upper bound for the area of the square.

..... cm² [2]

7 Find the positive integers that satisfy the inequality $t + 2 > 3t - 6$.

..... [3]

8 Solve the simultaneous equations.
You must show all your working.

$$\begin{aligned} \frac{1}{2}x + y &= 8 \\ x - 2y &= 2 \end{aligned}$$

$x =$

$y =$ [3]

- 9 From the top of a building, 300 metres high, the angle of depression of a car, C , is 52° .

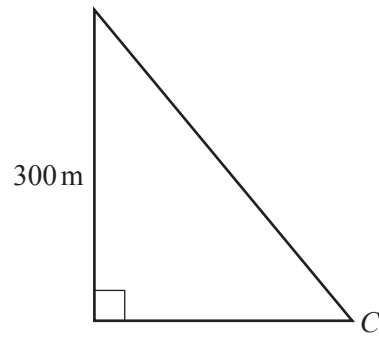

NOT TO
SCALE

Calculate the horizontal distance from the car to the base of the building.

..... m [3]

- 10 The length of a backpack of capacity 30 litres is 53 cm.

Calculate the length of a mathematically similar backpack of capacity 20 litres.

..... cm [3]

11

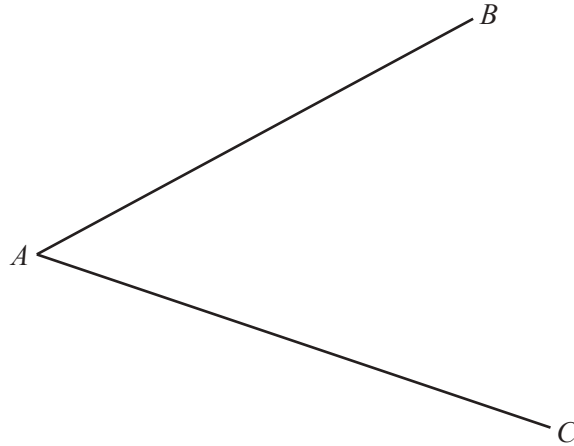

(a) Using compasses and a straight edge only, construct the bisector of angle BAC . [2]

(b) Complete the statement.

The bisector of angle BAC is the locus of points that are
 [1]

12 Ralf and Susie share \$57 in the ratio 2 : 1.

(a) Calculate the amount Ralf receives.

\$ [2]

(b) Ralf gives \$2 to Susie.

Calculate the new ratio Ralf's money : Susie's money.
 Give your answer in its simplest form.

..... : [2]

13 Factorise.

(a) $m^3 + m$

..... [1]

(b) $25 - y^2$

..... [1]

(c) $x^2 + 3x - 28$

..... [2]

14 **Without using your calculator**, work out $\frac{3}{4} + \frac{2}{3} - \frac{1}{8}$.

You must show all your working and give your answer as a mixed number in its simplest form.

..... [4]

15

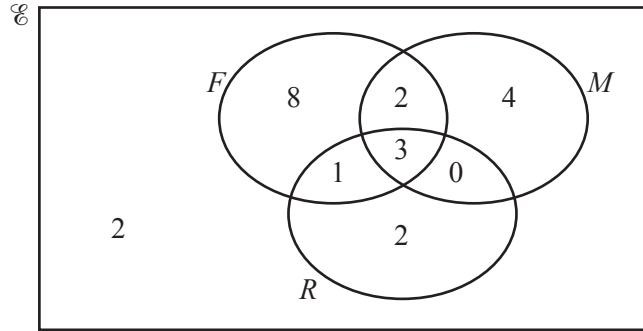

The Venn diagram shows the number of people who like films (F), music (M) and reading (R).

(a) Find

(i) $n(M)$,

..... [1]

(ii) $n(R \cup M)$.

..... [1]

(b) A person is chosen at random from the people who like films.

Write down the probability that this person also likes music.

..... [1]

(c) On the Venn diagram, shade $M' \cap (F \cup R)$.

[1]

16 $\vec{BC} = \begin{pmatrix} 2 \\ 3 \end{pmatrix}$ $\vec{BA} = \begin{pmatrix} -5 \\ 6 \end{pmatrix}$

(a) Find \vec{CA} .

$$\vec{CA} = \begin{pmatrix} \quad \\ \quad \end{pmatrix} [2]$$

(b) Work out $|\vec{BA}|$.

..... [2]

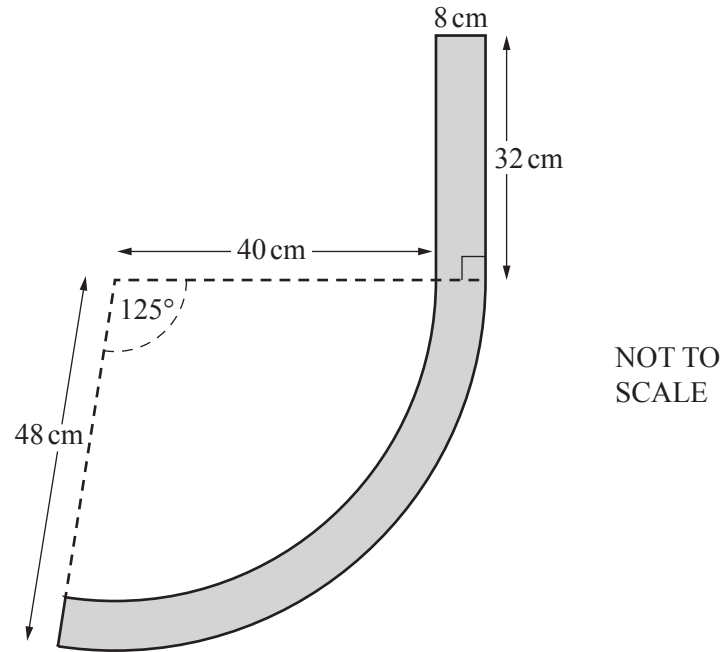

The diagram shows the cross section of part of a park bench.
 It is made from a rectangle of length 32 cm and width 8 cm and a curved section.
 The curved section is made from two concentric arcs with sector angle 125° .
 The inner arc has radius 40 cm and the outer arc has radius 48 cm.

Calculate the area of the cross section correct to the nearest square centimetre.

..... cm^2 [5]

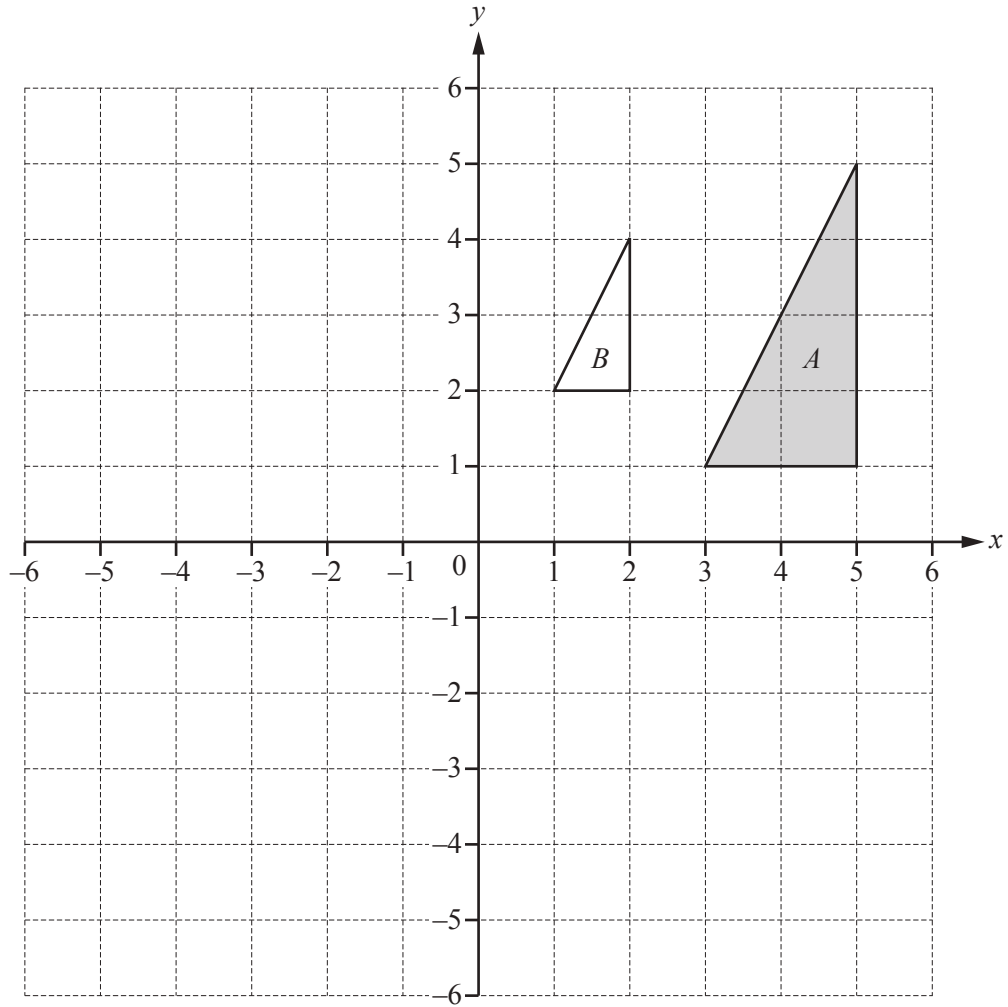

- (a) Describe fully the **single** transformation that maps triangle *A* onto triangle *B*.

.....
 [3]

- (b) Draw the image of triangle *A* after the transformation represented by $\begin{pmatrix} 1 & 0 \\ 0 & -1 \end{pmatrix}$. [3]

19 (a) Find the inverse of $\begin{pmatrix} 2 & -3 \\ 5 & -4 \end{pmatrix}$.

$\left(\quad \quad \right)$ [2]

(b) The matrix $\begin{pmatrix} w & -9 \\ 4 & w-12 \end{pmatrix}$ does not have an inverse.

Calculate the value of w .

$w = \dots\dots\dots$ [4]

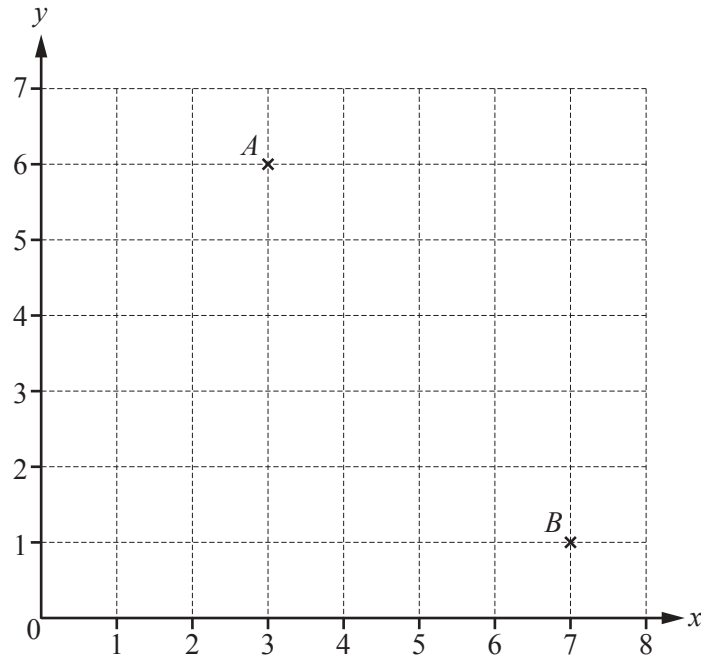

Point A has co-ordinates $(3, 6)$.

(a) Write down the co-ordinates of point B .

(.....,) [1]

(b) Find the gradient of the line AB .

..... [2]

(c) Find the equation of the line that

- is perpendicular to the line AB
- and
- passes through the point $(0, 2)$.

..... [3]

BLANK PAGE

Permission to reproduce items where third-party owned material protected by copyright is included has been sought and cleared where possible. Every reasonable effort has been made by the publisher (UCLES) to trace copyright holders, but if any items requiring clearance have unwittingly been included, the publisher will be pleased to make amends at the earliest possible opportunity.

To avoid the issue of disclosure of answer-related information to candidates, all copyright acknowledgements are reproduced online in the Cambridge International Examinations Copyright Acknowledgements Booklet. This is produced for each series of examinations and is freely available to download at www.cie.org.uk after the live examination series.

Cambridge International Examinations is part of the Cambridge Assessment Group. Cambridge Assessment is the brand name of University of Cambridge Local Examinations Syndicate (UCLES), which is itself a department of the University of Cambridge.